

AdRAM 540 and AdRAM 560D

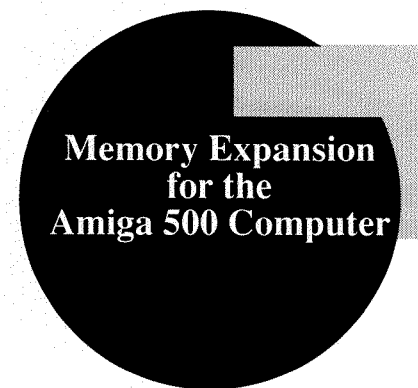
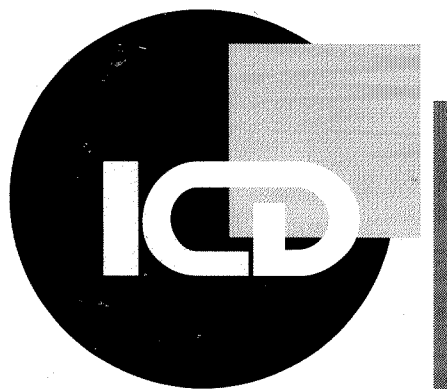

ICD Incorporated
1220 Rock Street
Rockford, IL 61101
USA

(815) 968-2228 Phone
(815) 968-6888 Fax

ICD Europe GmbH
Am Goldberg 9
6056 Heusenstamm
Germany

(0 61 04) 64 03 Telefon
(0 61 04) 67 58 1 Fax

50-90



For further information on this system contact ICD, Inc. at 815-968-2228 voice or 815-968-2229 BBS.

Note — throughout this manual the following notices apply:

AdRAM is a trademark of ICD, Inc.

Commodore is a registered trademark of Commodore Electronics Limited

Amiga is a registered trademark of Commodore-Amiga, Inc.

Kickstart, *Workbench*, and *Amiga DOS* are trademarks of Commodore-Amiga, Inc.

Published by ICD, Inc.

1220 Rock Street

Rockford, IL 61101-1437

U.S.A.

This manual and the software on the included diskette are copyright 1990 by ICD, Inc. All rights reserved. Printed in the United States of America. Reproduction or translation of any part of this work (beyond that permitted by sections 107 and 108 of the United States Copyright Act) without permission of the copyright owner is unlawful.

Notice: In no event will ICD, Inc. be liable for any damages whatsoever (including, without limitation, damages for loss of business profits, business interruption, loss of business information or the like) arising out of the use of, interruption in the use of, or inability to use this software and/or hardware, even if ICD, Inc. has been advised of any possibility or likelihood of such damages.

Introduction

The ICD AdRAM 540 will add up to 4 megabytes of random access memory (RAM) to your Amiga 500 computer. AdRAM 540 also contains a clock/calendar fully compatible with the Amiga DOS SetClock command, allowing your computer to always know the correct time and date.

The optional AdRAM 560D daughterboard will add an additional two megabytes of RAM, bringing your system total to 6.5 megabytes!

The additional RAM will allow you to run some programs that require more than the standard 512K, run more than one program at a time, and store data in a high speed RAMDISK. It will also let you work on larger projects with many other programs, such as word processors, paint programs, and music composition software.

The first 1.8 or 2 megabytes of extra RAM will automatically be detected and used by your computer. A small AdRAM program is used to tell your computer about the rest of the RAM.

Installation is simple, requiring no soldering for the basic installation. It does require opening the computer, however, which may void your warranty, so you should have the work done by your dealer if you have any doubts.

Note: ICD will also install and test your AdRAM 540 for \$40 (US only). Call for details and authorization at (815) 968-2228. If you want the advanced installation, be sure to mention it.

Be careful to avoid static electricity, which can damage your RAM chips, the AdRAM 540, and possibly your computer. Stay off carpeting if possible. Always touch a grounded metal surface before handling any of the components. Wear a grounded wrist strap if one is available.

If your computer has a Super ("fatter") Agnus chip, you can perform the advanced installation to double your chip RAM to 1 megabyte. This requires cutting a trace on the computer's motherboard and making two minor solder connections, so have your dealer or ICD perform this modification if you don't feel comfortable with it.

Note: If you have previously modified the motherboard to get one megabyte of chip RAM with a 512K addition, you will need to undo that modification first.

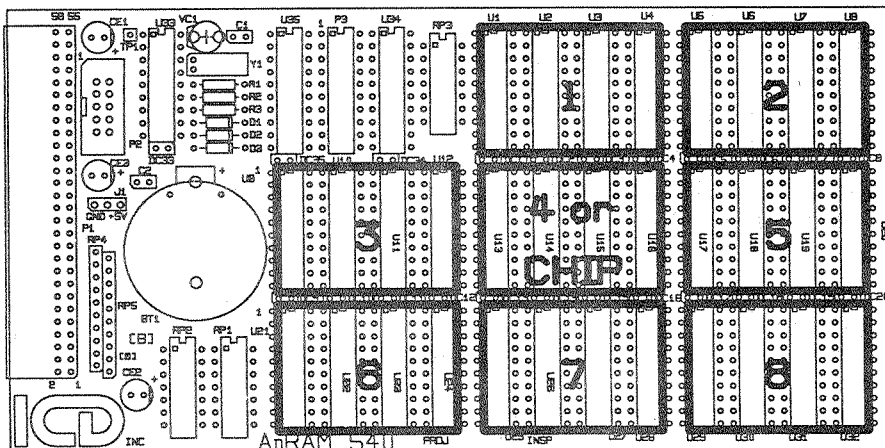

Figure 1

Partial List of Compatible Dynamic RAM Chips

Fujitsu MB81C4256	Hitachi HM514256
Intel 21014	Matsushita MN41C4256
Micron MT4C4256	Mitsubishi M5M44256
Motorola MCM514256	NEC uPD4242565
NMB AAA1M204	OKI MSM414256
Samsung KM44C256	Siemens HYB514256
TI TMS44C256	Toshiba TC514256

Needed Equipment

You will need the following supplies to install your AdRAM 540:

- A size T-10 Torx® screwdriver
- An X-Acto® or similar knife, diagonal cutting pliers, or some other cutting tool
- A small flat bladed screwdriver

To perform the optional advanced installation, you will also need these:

- An X-Acto® or similar knife
- A 30 watt soldering iron (*not* higher)
- Some 60/40 tin/lead .032" diameter .031 rosin core solder

Adding RAM to the AdRAM 540

If your AdRAM 540 is unpopulated, you will need to install up to 32 RAM chips on the board in groups of four. These must be CMOS 256K×4 dynamic RAM chips, 120 nanosecond or faster.

Figure 1 shows the outline of the board. The heavy lines show the chip groups. If you are performing the basic installation, you should insert the first four chips in U1–U4, the next four in U5–U8, the next four in U9–U12, and the next four in U13–U16. The notch or dot on all the RAM chips should be toward the notch in the socket (toward the top of the board).

If you have a Super ("fatter") Agnus and are performing the advanced installation, you should put the first in U13–U16, the second in U1–U4, the third in U5–U8, and the next in U9–U12.

The next two megabytes should be added to the U17–U20, U21–U24, U25–28, and U29–U32 groups.

Note: The board socket labels (U1, U2, etc.) may be covered by the sockets. Refer to figure 1 for identification.

You do not need to add the RAM all at once, but you *must* add it four chips at a time and in the stated order.

Changing the Configuration Jumpers

Once you have added RAM chips to the AdRAM 540, you may need to set jumpers J2B and J3B on the secondary board (figure 2) to reflect the amount of RAM in the first four banks.

Jumper Positions				
RAM	0.5 Meg	1.0 Meg	1.5 Meg*	1.8 Meg
J3B				
J2B				

* Not available with Kickstart 1.2

Table 1

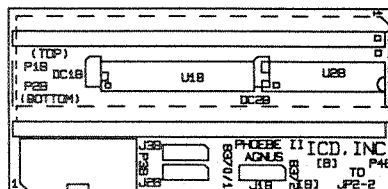

Figure 2

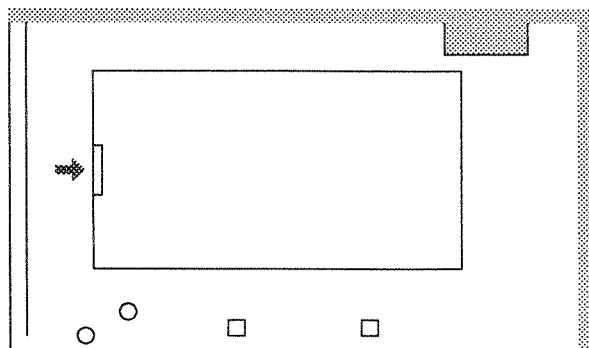

Figure 3

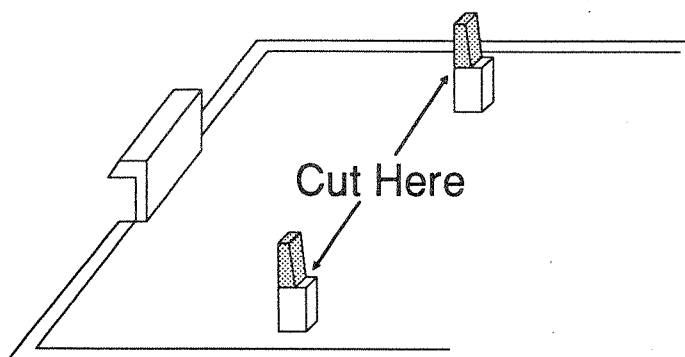

Figure 4

Following table 1 move the jumpers to the proper position. If you perform the advanced installation, you should not count the CHIP RAM bank when selecting the positions for these jumpers. For example, if you add two banks of RAM chips to the AdRAM 540 and perform the advanced installation, you should configure the jumpers for 0.5 meg.

Note: If you are using Kickstart 1.2, then the 1.5 meg configuration is not available. If you wish to add 1.5 megs with the basic installation or 2 megs or more with the advanced installation, you can't use bank U9-U12 on the AdRAM 540 main board. Use bank U17-U20 or higher instead, and access the RAM with the AdRAM program.

Installing the AdRAM 540

Disconnect your monitor, mouse, power cord, and anything else connected to your computer. Turn the computer keyboard down and locate the door covering the expansion bay as shown in figure 3. Using a small coin or flat-bladed screwdriver, open this door.

On the inside surface of the door are two plastic standoffs (figure 4). The thinner tops of these standoffs (shaded in the diagram) should be cut off with the diagonal cutting pliers or the knife. This is necessary because the AdRAM 540 main board is will extend beyond these.

You can install the AdRAM 540 main board at this time, but you will be opening the computer, and it is much easier to install with your computer open.

Opening Your Computer

You will need a T-10 Torx® screwdriver. Turn your computer upside down. Remove the three screws along the front edge of your computer and the three along the rear edge. Turn the computer back up and lift the cover off. Note that you may have to move the cover slightly to the right to get it over the floppy drive eject button.

Note the orientation of the cable going from the keyboard to the main board of your computer. Either record the colors or mark the connector so that you will be able to replace it correctly. Unplug this cable and the ground strap that connects the keyboard to the shield around the floppy drive. Then lift the keyboard slightly backward and off.

Remove the four Torx screws holding the upper shielding in place. These are around the front left side.

Bend up four tabs holding the shielding in place. Three are near the floppy diskette drive and one is at the back left corner. Lift the shielding off.

Installing the AdRAM 540 Secondary Board

At this point you should perform the advanced installation steps if you wish.

Locate the Gary chip in the center of your computer. GARY will be written on the circuit board beside it. *Carefully* remove Gary from its socket by gently prying it up from both ends alternately with a flat-bladed screwdriver. Make sure you are prying between Gary and the socket, *not under the socket!*

Install Gary in the AdRAM 540 secondary board (figure 2). Note that pin one is to the right, so the writing on Gary will be upside down compared to the writing on the secondary board. Make sure that all of Gary's pins go in the socket cleanly.

Install the AdRAM 540 secondary board in the socket from which you removed Gary. Make sure that pin one on Gary still points to the right, the writing on the secondary board is right side up, and the connectors are toward the bottom.

Installing the AdRAM 540 Main Board

Lift up the front of the computer and put the main AdRAM 540 board into the bay from below. Push the board firmly to the left so that the connector slides onto the pins on the computer's main board. Note that the pins will not be completely covered by the connector when it is seated.

Connecting the Boards

Connect the ribbon cable to both the main board and the secondary board. Note that these connectors are keyed. Do not force them.

Closing the Computer

Replace the shielding and close up your computer, following the directions for opening it in reverse.

Installation is complete! Your computer is now ready to use with more RAM.

Advanced Installation

If you have a Super ("fatter") Agnus you may configure your AdRAM 540 and perform some minor soldering to get a full megabyte of chip RAM.

Locate the Angus chip on your computer's circuit board. It is to the left of Gary and is marked FAT AGNUS on the board. Check the first number on it. If it is 8370 or 8371, you do not have a Super ("fatter") Agnus and advanced installation will not increase your available CHIP RAM. If the number is 8372 or higher, you do have one.

Locate jumper JP2 on the computer's motherboard. It is to the right of the 68000 (the large chip mounted vertically on the left edge of the board). This jumper is three square pads, the lower two connected. *Carefully* cut the trace connecting the lower two pads with the knife. Make sure to completely break the connection between the two pads.

Solder the supplied jumper wire to the AdRAM 540 secondary board in the hole labeled TO JP2-2. Install Gary and this board as described earlier.

Once the secondary board is in place, solder the other end of the jumper wire to the middle pad of JP2. Make sure you don't "bridge" (short) to either of the other pads.

Change the jumper on the secondary board from the default 8370/1 position to 8372 by lifting the plastic jumper and covering the middle and right pins.

You should now install the AdRAM 540 main board and close the computer as described earlier.

Note: If you have a revision 6 motherboard, have added RAM chips to it, and made the jumper modifications to have one meg of chip RAM on the board, you will need to undo this. The easiest way, if the RAM chips are socketed, is to remove them and place them in the AdRAM 540 main board. If they are soldered directly to the board, cut the trace between the lower pads of JP3 (to the right of the RAM chips) and connect a jumper wire between the lower right pad and a +5v source.

Installing the AdRAM 560D

You *must* have the U1-U4 bank of your AdRAM 540 filled before adding an AdRAM 560D, whether you have a Super Agnus or not. *You do not need to fully populate your AdRAM 540*, but you must have the first bank filled. If you have a Super Agnus and have performed the advanced installation, you should have at least *two* banks (U9-U12 and U1-U4) filled on your AdRAM 540.

You must first perform the advanced installation as described earlier before using the AdRAM 560D. *If you do not have a Super ("fatter") Agnus, do not*

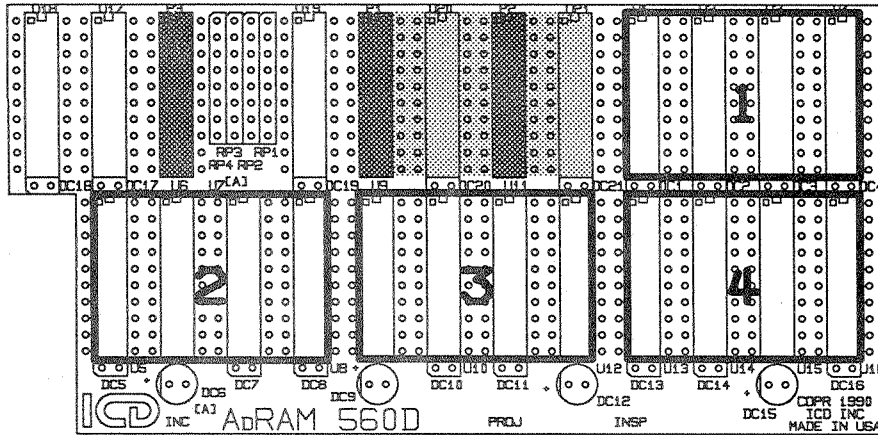

Figure 5

change jumper J1B on the AdRAM 540 secondary board. Other than this jumper, the advanced installation is the same.

With your computer open as described earlier, disconnect the ribbon cable from the AdRAM 540 main board and remove it from the computer. Then remove the RAM chips from sockets U1 and U3 on the AdRAM 540 main board. Insert these RAM chips into sockets U20 and U21 on the AdRAM 560D board (figure 4).

Place the AdRAM 560D board above the AdRAM 540 main board so that the pins below P3, P1, and P2 on the AdRAM 560D board line up with sockets P3, U1, and U3 on the AdRAM 540 main board. Carefully but firmly press these pins into the sockets, making sure that they all go in straight.

Replace the AdRAM 540 main board in your computer and reconnect the ribbon cable. Close your computer as described earlier and reconnect your peripherals.

Disabling the additional RAM

Jumper J2-2 on the AdRAM 540 main board is used to disable or enable the added Fast RAM. To enable the RAM, make sure the jumper plug is in the EN position. To disable it, move the jumper plug to the DIS position. The clock will still be functional when the RAM is disabled, as will any additional Chip RAM.

You may install a single pole double throw switch with three wires to these jumper pins and mount the switch externally so that you may enable or disable the RAM without opening the computer.

Using the AdRAM Program

The first four banks of RAM added to the AdRAM 540 are automatically recognized by your computer and can be used by any program looking for FAST RAM. To use the other four, and the four banks in the AdRAM 560D, you need to run the supplied AdRAM program.

Note: If you do not have a Super ("fatter") Agnus or have not performed the advanced installation, and you have installed at least four banks of RAM in your AdRAM 540, then half of the last bank will not be automatically recognized. Running the AdRAM program will allow you to use this extra 256K.

AdRAM should be run from a CLI or shell. The easiest way to use it is to add the line

AdRAM

to the startup-sequence in your S: directory.

AdRAM automatically recognizes the amount of RAM it needs to add to the system and does so.

Testing the AdRAM 540 and AdRAM 560D

All AdRAM 540 and AdRAM 560D units are tested thoroughly before leaving ICD. The most likely reason for failure is a defective RAM chip or improper installation. The program MemTest on the supplied diskette will test *all* memory in your system and report any errors found.

The AdRAM diskette is not bootable, so boot with your normal Workbench™ diskette, then insert the AdRAM diskette into any drive. Open the disk by double-clicking on its icon. Run the test by double-clicking on the MemTest icon.

Note: To test the extra RAM that is not automatically recognized by the system, you need to run the AdRAM program *before* running MemTest.

The program runs continuously. Press the RETURN key to exit. The screen will flicker when chip memory is being tested. This is supposed to happen.

If an error occurs, the address and bad bits will be printed as hexadecimal numbers. The address range for the first bank is C00000 to C7FFFF; for the second, C80000 to CFFFFF; for the third, D00000 to D7FFFF; and for the fourth, D80000 to DBFFFF and F40000 to F7FFFF (080000 to 0FFFFFF with a Super ("fatter") Agnus and motherboard modification).

The address range for the fifth bank is 800000 to 87FFFF; for the sixth, 880000 to 8FFFFFF; for the seventh, 900000 to 97FFFF; and for the eighth, 980000 to 9FFFFFF.

The range for the first bank of the 560D is 600000 to 67FFFF; for the second, 680000 to 6FFFFFF; for the third, 700000 to 77FFFF; and the fourth, 780000 to 7FFFFFF.

If an error occurs in these ranges, you can determine the faulty RAM chip by examining the bad bits number. The right most digit and the fifth from the right correspond to the first chip of the bank, the second and sixth from the right to the second chip of the bank, the third seventh from the right to the third chip of the bank, and the fourth and eighth from the last chip of the bank.

Using the Real Time Clock

The clock on the AdRAM 540 is completely compatible with the Amiga DOS SetClock command.

To set the time on the board, boot with your Workbench diskette, open a CLI or shell window, and type

```
date 13-Mar-90 18:01:45
```

(substituting the correct date and time, of course). This sets the system's date and time. Then type

```
setclock opt save
```

This sets the clock on the AdRAM 540 to the current system date and time.

To load the date and time when you boot, add the line

```
setclock opt load
```

into your startup-sequence. The startup-sequence that comes with Workbench 1.3 already has this line in it.

Compatibility

The AdRAM 540, with or without the AdRAM 560D, reduces the available auto-configuration address space from eight megabytes to four megabytes,

regardless of the amount of RAM installed. This means that you can add a maximum of four megabytes of auto-config devices on the expansion port of the side of the computer. At this time RAM cards (often in cases with hard drives, such as the Commodore A590) are the only such devices available.

The RAM provided with the AdRAM 540 is fully recognized by your computer as FAST RAM. There should be no software compatibility problems.

Battery Replacement

AdRAM 540 uses a standard 3 volt lithium battery that should last 3 to 5 years. When the voltage across the battery drops below 2.2 volts, it needs to be replaced. You can purchase a replacement battery directly from ICD or from other sources.

A lithium battery is used instead of a rechargeable NiCad battery because it is less expensive, doesn't require additional trickle charge circuitry, and has the same life expectancy.

Conclusion

Every effort has been made to insure that your AdRAM 540 will be easy to install and give you years of service. If you have any question, comment, or problem, feel free to contact us by mail at the address in the front of the manual, by phone at (815) 968-2228, or by modem on GENIE (ICDINC), CompuServe (76004,1600), or our BBS at (815) 968-2229.

Other Amiga Products from ICD

ICD offers a variety of products for Amiga computers, and more are under development. Everything is designed and assembled in-house, a fully integrated development and production system that leads to unsurpassed quality.

If you don't see what you want here, give us a call. We may already have such a product, but even if we don't we are always interested in hearing what you have to say.

Flicker Free Video

Finally, an answer to interlace flicker for all Amiga computers! With Flicker Free Video and a standard VGA or multi-sync monitor, you can have a clean, crisp display, free of interlace jitter and visible scan lines, for any Amiga 500,

1000, or 2000. With fully overscan and PAL/NTSC support, Flicker Free Video is the answer.

AdSpeed

This 68000 based accelerator will speed up your Amiga like no other. 32K of high speed static RAM gives you a 16K cache that will speed up everything your computer does. Running at twice the normal clock speed, AdSpeed doesn't depend on special programs to get its speed. And you can switch it off, to keep your computer compatible with even the most troublesome software, and you can switch the speeds while the computer is running. Programs typically show a 80% to 100% improvement in performance.

AdRAM 2080

Add two, four, six, or eight megabytes of auto-configured fast RAM to your Amiga 2000 with the AdRAM 2080 board from ICD. You can add the RAM in two megabyte groups at any time — no need to fill it up at once. And the six megabyte configuration is great if you have an accelerator card or bridge board, allowing you to add all the RAM possible. Standard 1 meg by 1 bit RAM chips are used.

AdSCSI 2000

If you want speed, reliability, and flexibility in a hard drive interface for your 2000, you need an AdSCSI 2000. Advanced software and a clean design make this SCSI host adapter the fastest we have seen for the Amiga. Formatting and setup couldn't be easier. Removable media drives are fully and transparently supported. Up to seven drives (or other SCSI devices) may be added to each AdSCSI 2000, and up to four AdSCSI 2000s may be put in each computer. Auto-booting with Kickstart 1.3 and above is, of course, supported. AdSCSI 2000's half-card design and supplied mounting frame make "hard drive card" assembly a snap.

AdSCSI 2080

For applications where expansion slots in your Amiga 2000 computer are in high demand, the AdSCSI 2080 combines all the features of the AdSCSI 2000 (except the "hard drive card" option) and the AdRAM 2080. Standard 1 megabyte SIMMs allow you to add zero, two, four, six, or eight megabytes of RAM to your computer. The SCSI host adapter is the same design as the AdSCSI 2000, providing the same high speed and removable media support.

Amiga Memory Map

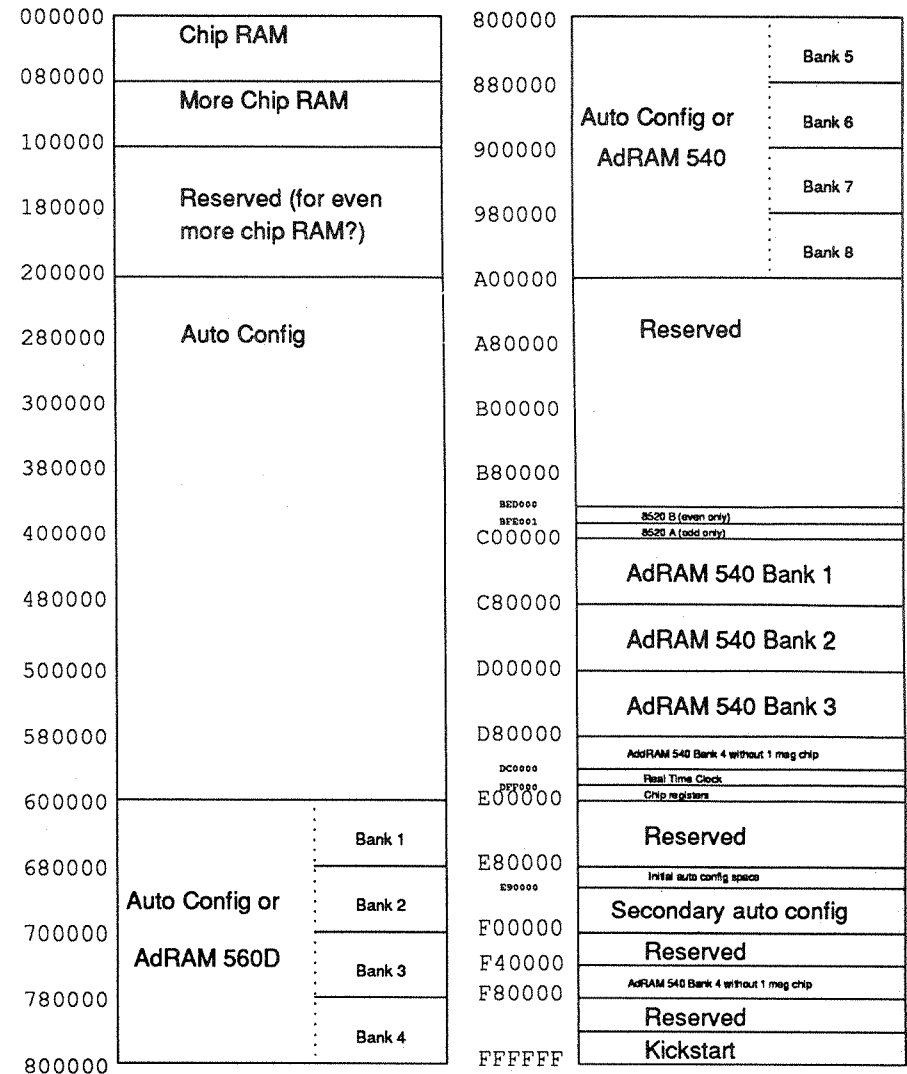

Important Warranty Information

Limited Warranty

ICD, Inc. warrants to the original consumer purchaser that these **ICD, Inc.** Personal Computer Products (not including computer programs) shall be free of defects in material or workmanship for a period of 90 days for diskettes and one year for hardware from the date of purchase. If any such defect is discovered within the warranty period, **ICD, Inc.**'s sole obligation will be to repair or replace, at its election, the Computer Product free of charge on receipt of the unit (charges prepaid, if mailed or shipped) with proof of date of purchase satisfactory to **ICD, Inc.**

Write to:

ICD, Inc.
1220 Rock Street
Rockford, IL 61101-1437
Attn: Service Department

YOU MUST RETURN THE DEFECTIVE COMPUTER PRODUCT FOR IN-WARRANTY REPAIR.

This warranty shall not apply if the Computer Product: (i) has been misused or shows signs of excessive wear, (ii) has been damaged by improper installation, or (iii) has been damaged by being serviced or modified.

ANY APPLICABLE IMPLIED WARRANTIES, INCLUDING WARRANTIES OF MERCHANTABILITY AND FITNESS FOR A PARTICULAR PURPOSE, ARE HEREBY LIMITED TO THIRTY DAYS FROM THE DATE OF PURCHASE. CONSEQUENTIAL OR INCIDENTAL DAMAGES RESULTING FROM A BREACH OF ANY APPLICABLE EXPRESSED OR IMPLIED WARRANTIES ARE HEREBY EXCLUDED. Some states do not allow limitations on how long an implied warranty lasts or do not allow the exclusion or limitation of incidental or consequential damages, so the above limitations or exclusions may not apply to you.

This warranty gives you specific legal rights, and you may also have other rights which vary from state to state.

DISCLAIMER OF WARRANTY ON ICD, Inc. COMPUTER PROGRAMS: All **ICD, Inc.** computer programs are distributed on an "as is" basis without warranty of any kind. The entire risk as to the quality and performance of such programs is with the purchase. Should the programs prove defective after their purchase, the purchaser and not the manufacturer, distributor, or retailer assumes the entire cost of all necessary servicing or repair.

ICD, Inc. shall have no liability or responsibility to a purchaser, customer, or any other person or entity with respect to any liability, loss, or damage caused directly or indirectly by computer programs sold by **ICD, Inc.** This disclaimer includes but is not limited to any interrupts of service, loss of business or anticipatory profits, or consequential damages resulting from the use or operation of such computer programs.

REPAIR SERVICE: If your **ICD, Inc.** Personal Computer Product requires repair other than under warranty, please write to **ICD, Inc.**, Service Department for repair information.

IMPORTANT: If you ship your **ICD, Inc.** Personal Computer Product, package it securely and ship it, charges prepaid and insured, by parcel post or United Parcel Service.